



# E702B

## DIRECT VIEW STORAGE TUBE

Service Type CV5987

The data should be read in conjunction with the Storage Tube Preamble.

### INTRODUCTION

The E702B is a direct view storage tube with a useful viewing screen diameter of 4 inches (102mm). It is designed to provide very bright displays of information ranging from single transients and recurrent waveforms to half-tone pictures. The writing gun beam is electrostatically deflected, and high stored writing speeds, 1.0 inch per microsecond, can be achieved. The tube is of ruggedized construction and is recommended for airborne and other radar applications where vibration and low pressure conditions may be encountered.

The tube has two electron guns, one for writing the signal on to the storage surface and the other, the flood gun, for displaying written information on the viewing screen. The writing gun is similar to that in a conventional cathode ray tube, except that it need only be operated for a single trace. In writing, a charge pattern is deposited on the storage surface, which consists of an insulator coating on a metal mesh (the backing electrode). Low velocity electrons from the flood gun approach the storage mesh normally and at constant current density over the useful area. They penetrate the mesh in those areas where a charge pattern has been written, the number doing so being determined by the amount of charge deposited, and are then accelerated to the viewing screen where they produce an image.

Since the flood gun is normally continuously operative, the image on the viewing screen persists without deterioration for one to two minutes, and is visible for periods up to ten minutes. The charge pattern written on the storage surface can be retained for extended periods by switching off the flood beam until viewing is required, provided that no writing takes place while the flood gun is inoperative. The image can be completely erased in a fraction of a second by applying a small positive pulse to the backing electrode; controlled persistence can be obtained by varying the duration of shorter repetitive pulses.

June 1972

## GENERAL

### Electrical and General

	Writing Gun	Flood Gun	
Cathodes, indirectly heated, oxide coated . . . . .	one	one	
Heater voltage . . . . .	6.3	6.3	V
Heater current . . . . .	0.6	0.6	A
Cathode heating time (minimum) . . . . .	see note 1	45	s
Inter-electrode capacitances:			
cathode to all other electrodes . . . . .	4.0		pF
grid 1 to all other electrodes . . . . .	7.0	24	pF
X1 plate to all other electrodes . . . . .	11.5	—	pF
X2 plate to all other electrodes . . . . .	11.5	—	pF
Y1 plate to all other electrodes . . . . .	6.5	—	pF
Y2 plate to all other electrodes . . . . .	9.5	—	pF
X1 to X2 plates* . . . . .	2.0	—	pF
Y1 to Y2 plates* . . . . .	2.0	—	pF
writing gun grid 1 to writing gun cathode* . . . . .	1.5	—	pF
backing electrode to all other electrodes . . . . .	—	74	pF
screen to all other electrodes . . . . .	—	32	pF
Focus method . . . . .	electrostatic	electrostatic	
Deflection method . . . . .	electrostatic	none	
Phosphor . . . . .	—	aluminized P20	
Fluorescent colour (see spectral characteristic) . . . . .		yellow-green	

### Mechanical

Overall length . . . . .	15.500 inches (393.7mm) max	
Overall diameter (excluding flexible lead) . . . . .	5.437 inches (138.1mm) max	
Bulb diameter . . . . .	5.312 inches (134.9mm) max	
Useful viewing screen diameter . . . . .	4.000 inches (101.6mm) min	
Net weight . . . . .	2½ pounds (1.15kg) approx	
Mounting position . . . . .	any	
Base . . . . .	31-pin small button thirty-five (JEDEC no. E31-36)	
Bulb cavity caps (six) . . . . .	B.S.448-CT8 (JEDEC no. J1-21)	
Viewing screen connection . . . . .	flexible lead	

\* With all other electrodes earthed

**MAXIMUM AND MINIMUM RATINGS (Absolute values)**

No individual rating should be exceeded

All voltages are with respect to the flood gun cathode unless otherwise stated

**Writing Gun**

	Min	Max	
Heater voltage	6.0	6.6	V
Grid 4 voltage			see note 2
Grid 3 voltage (negative value)	-	2500	V
Grid 2 voltage	-	200	V
Grid 1 voltage:			
negative bias*	0	200	V
positive peak*	-	2.0	V
Cathode voltage (negative value)	-	2800	V
Peak heater to cathode voltage:			
heater positive with respect to cathode	-	125	V
heater negative with respect to cathode	-	125	V
Cathode current (peak)	-	1.0	mA
Grid to cathode circuit impedance	-	1.0	MΩ
Deflection plate circuit impedance	-	0.1	MΩ

**Flood Gun**

	Min	Max	
Heater voltage	6.0	6.6	V
Viewing screen voltage	-	12	kV
Backing electrode voltage (peak) (see note 3)	-	20	V
Grid 4 (collector mesh) voltage	-	300	V
Grid 3 voltage	-	300	V
Grid 2 voltage (see note 2)	-	200	V
Grid 1 voltage:			
negative bias (never positive)	2.0	150	V
Peak heater to cathode voltage:			
heater positive with respect to cathode	-	125	V
heater negative with respect to cathode	-	125	V
Cathode current (mean)	-	2.0	mA
Viewing screen dissipation	-	6.0	W
Backing electrode supply impedance	-	5000	Ω
Grid to cathode circuit impedance	-	0.5	MΩ
Viewing screen supply impedance (see note 4)	1.0	5.0	MΩ

\* With respect to Writing Gun Cathode.

## TYPICAL OPERATION

All voltages are with respect to the flood gun cathode unless otherwise stated

### WRITING GUN

#### Operational Conditions

Grid 4 voltage		see note 2
Grid 3 voltage (usual range for focus)*	450 to 650	V
Grid 2 voltage	0	V
Grid 1 voltage (range for writing beam cut-off)*	-45 to -110	V
Cathode voltage	-180V	V

#### Typical Performance

Writing beam current (50V modulation) (see note 5)	49	$\mu$ A
Cathode current (50V modulation)	700	$\mu$ A
Deflection factor, X plates	90	V/inch
Deflection factor, Y plates	87	V/inch
Stored writing speed (see note 5)	1	inch/ $\mu$ s

### FLOOD GUN

#### Operational Conditions

Screen voltage	10	kV
Backing electrode d.c. voltage	2.0	V
Erase pulse amplitude for screen cut-off (see notes 6 and 7)	3.9	V
Grid 4 (collector mesh) voltage	225	V
Grid 3 voltage (see note 8)	90	V
Grid 2 voltage	150	V
Grid 1 voltage (see note 8)	35	V
Cathode voltage	0	V

#### Typical Performance

Screen current for full brightness	0.48	mA
Cathode current	1.3	mA
Screen luminance (see note 9)	2150	ft-lamberts
	7375	cd/m <sup>2</sup>
Viewing time (see note 10):		
minimum	30	s
typical	60	s
Resolution (see note 11)	100	lines/inch

\* With respect to Writing Gun Cathode.

## NOTES

1. To prevent the occurrence of transients when switching on or off, the writing gun heater voltage may be applied simultaneously with, or after, the other writing gun voltages, and switched off before these voltages are removed, provided the writing gun is biased to beyond cut-off.
2. Grid 4 (writing gun) is internally connected to grid 2 (flood gun).
3. Except when the faults mentioned under Pulse Erasure, part (c), of the General Instructions on page 7 are being corrected,
4. The viewing screen supply impedance should be less than  $5M\Omega$  to prevent excessive changes in screen voltage during erasure.
5. Writing is a charge deposition process and the current required for a given brightness level is proportional to the writing speed and inversely proportional to the number of times the information is written in one place.
6. With manual erasure (approximately 1 second) and the screen voltage simultaneously removed.
7. Maximum screen brightness is obtained when the storage mesh surface has stabilized at approximately zero potential, i.e. flood gun cathode potential. The application of a positive manual erase pulse to the backing electrode produces a corresponding positive increase in the storage mesh surface potential. This surface potential is reduced to near flood gun cathode potential by flood beam electrons. When the erase pulse is removed the surface acquires a negative potential relative to that at full brightness and equal in value to the erase pulse amplitude.
8. To achieve collimation of the flood beam, the voltages applied to the flood gun grids 2, 3 and 4 should be preset to the fixed values given on page 4. The voltage of grid 1 should then be adjusted to just give maximum uniform display over the screen. The voltage of grid 3 should then be adjusted to give the most uniform erasure when a train of erasing pulses is applied to the backing electrode. Slight readjustment of grid 1 voltage may assist in obtaining the most uniform erasure.
9. The meter used for measuring screen luminance has been corrected to the frequency response of the human eye.

10. Time for background to rise from cut-off to 10% of maximum brightness. An increase in viewing time can be obtained by switching off the flood beam by pulses at a frequency sufficiently high to prevent flicker, the apparent brightness of the display being proportionately reduced.
11. Using a test card C pattern produced from a monoscope generator and written for one frame only at a level to display all five half-tones.

## GENERAL INSTRUCTIONS

### Handling

The tube should be transported screen upwards to prevent particles falling on the storage elements. It should be handled with care to avoid damage to the metal seals and the encapsulated screen lead.

### Magnetic Shielding

Because of the low voltage of the flood gun beam, it is essential to shield the whole of the viewing section from magnetic fields; shielding of the writing gun is also advisable. Details of suitable Mumetal shields are available from English Electric Valve Company Ltd.

### Demagnetization

The tube may become magnetized during transportation and this will cause non-uniform illumination under full brightness conditions. In this event, a degaussing coil should be drawn slowly over the tube taking one minute for the operation. Such a coil may be made up of 900 turns of no. 16 s.w.g. enamelled wire wound on a 6½-inch diameter former 2 inches long. The coil supply voltage should be 115 volts 50 to 60Hz a.c. Stronger fields should not be used.

### Pulse Erasure

(a) The speed of erasure is controlled by the adjustment of the pulse duration in conjunction with the pulse repetition rate, which should be sufficiently high to prevent flicker, and preferably in the range between 100 and 2000 pulses per second. By increasing the pulse duration or the pulse repetition rate, the erasure time may be reduced proportionately. The pulse amplitude also alters the erase rate but primarily determines the final potential to which the storage mesh is driven in the absence of writing (see pages 11 and 12).

Normally a pulse amplitude two to three times the manual erase value is applied, which gives an approximately uniform rate of erasure for visible signals but tends to suppress small non-integrating signals such as noise. A much lower pulse amplitude must be used if the grey scale is to be preserved with no loss of information.

(b) If it can be conveniently arranged for the screen h.t. to be switched off simultaneously with either manual or pulse train erase then two advantages will ensue:

- (i) Contrast during pulse train erase will improve.
- (ii) The time taken for erasure will decrease.

(c) The normal erasure procedure may be inadequate or ineffective under the following conditions:

- (i) When writing beam electrons have penetrated the surface of the storage insulator and have built up charges within it. Low velocity flood beam electrons cannot neutralize these charges and after the normal erasure procedure has been carried out the original screen image may still be faintly visible as the background illumination increases.
- (ii) When parts of the storage mesh surface are driven so positive that the number of secondary electrons produced by the flood beam exceeds those arriving at the surface. This condition is known as runaway charging and can occur when a pulse exceeding 20 volts in amplitude is applied to the backing electrode. It can also occur when an excessively high writing charge is deposited, e.g. with a stationary spot or line and particularly when writing takes place in the absence of flood beam current. Damage may be done to the storage mesh if this fault is not quickly corrected.

Both faults can be corrected by operating a switch to disconnect the backing electrode from its supply and connecting it to the flood gun grid 4 through a protective resistor; this switch must make and break quickly and need be operated once only. The screen should then be at uniform full brightness and normal erasure will prepare the tube for operation. Care should be taken to ensure that this switch cannot be left in the 'on' condition. The above procedure is known as 'clearance'.

### **Flood Gun**

The flood gun supplies must be held relatively stable. The flood gun grid 2 is internally connected to the writing gun grid 4 and the potential of this point relative to earth is normally fixed by the mean potential of the deflecting system (see Deflection Supplies below).

To prevent the occurrence of runaway charging, the flood gun beam must always be operative before the writing gun supplies are switched on.

### **Writing Gun**

The writing gun cathode is operated at a potential in the region of  $-1.5$  to  $-2.8$  kV; consequently the heater supply should be adequately insulated. The cathode supply must be free from ripple to prevent modulation of the writing beam and have good stability to maintain constant modulation depth and focus.

Care should be taken to prevent heavy transient writing beam currents when switching on. The writing beam should be adjusted so that the highlight brightness of the display is not saturated as this will result in a rapid deterioration in resolution.

### **Deflection Supplies**

The mean potentials of the deflecting plates should be held very close to the writing gun grid 4 voltage, and astigmatism of the writing beam may be minimized by small adjustments of the potential differences between them. The undeflected writing beam will normally focus to a spot at the centre of the storage mesh. To compensate for variations between individual tubes, however, an adjustable and reversible supply to the deflection plates should be provided for centring the writing beam spot.

Any failure of the deflection drive that may result in the production of a stationary spot or line may cause runaway charging, even with the flood beam on. Provision should be made for automatically cutting off the writing gun beam in the event of any such failure.



# TYPICAL WRITING GUN CHARACTERISTIC

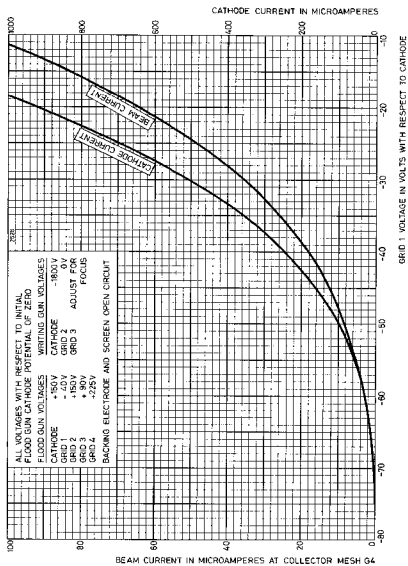

# TYPICAL SCREEN BRIGHTNESS CHARACTERISTIC

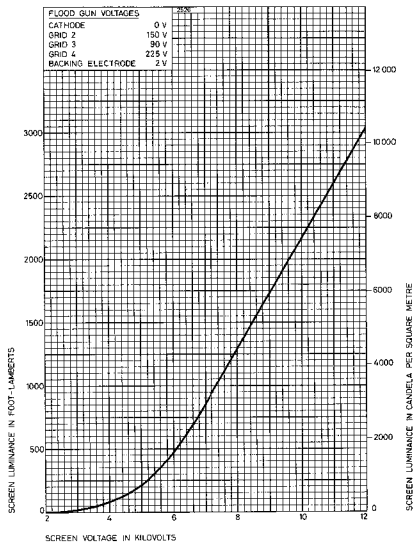

# TYPICAL RELATIVE BRIGHTNESS CHARACTERISTICS

Obtained by applying repetitive erase pulses

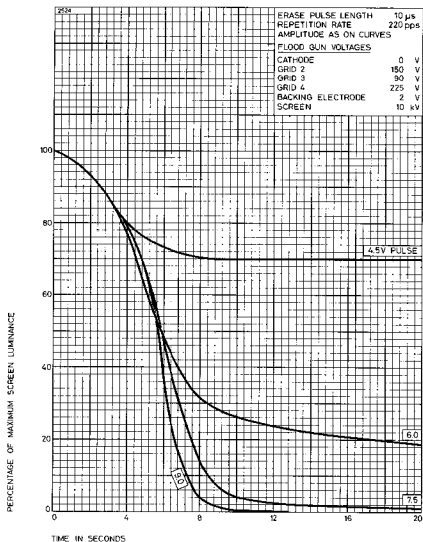

## TYPICAL STORAGE MESH CHARACTERISTIC

Obtained by applying manual erase pulses

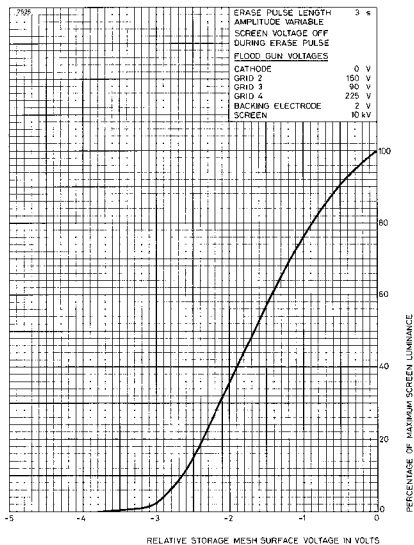

The storage mesh surface potential is arbitrarily considered zero at full brightness for the purpose of this graph.

TYPICAL SPECTRAL OUTPUT CHARACTERISTIC FOR P20 PHOSPHOR

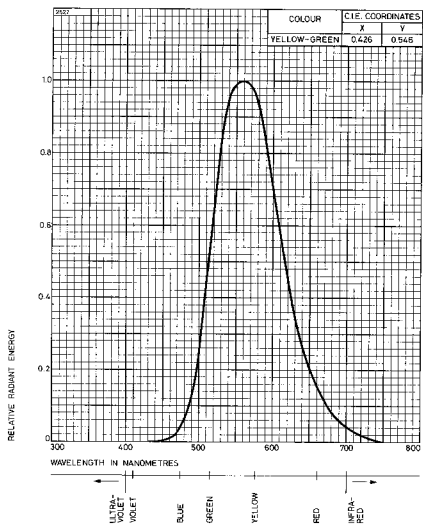

## OUTLINE

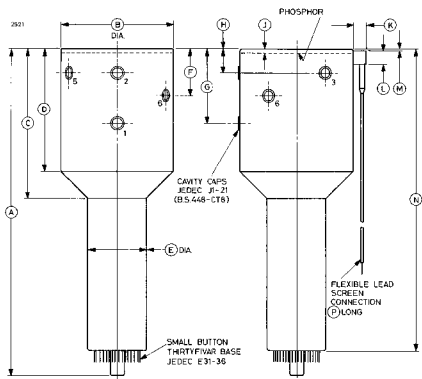

Ref	Inches	Millimetres	Ref	Inches	Millimetres
A	15.250 ± 0.250	387.4 ± 6.4	K	0.625 max	15.88 max
B	5.312 max	134.9 max	L	0.563 max	14.30 max
C	7.000 max	177.8 max	M	0.062	1.58
D	5.750 max	146.1 max	N	14.125 ± 0.250	358.8 ± 6.4
E	3.094 max	78.59 max	P	22.5	571.5
F	2.188 ± 0.125	55.58 ± 3.18	Q	0.062 max	1.58 max
G	3.500 ± 0.125	88.90 ± 3.18	R	0.625 max	15.88 max
H	1.125 ± 0.125	28.58 ± 3.18	S	5.437 max	138.1 max
J	0.250 ± 0.025	6.35 ± 0.64			

Millimetre dimensions have been derived from inches.

## OUTLINE

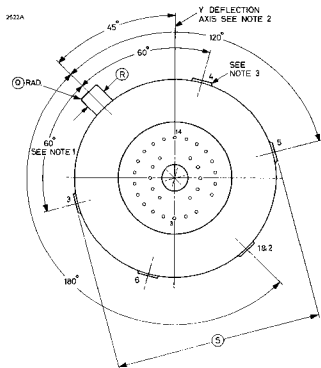

### Outline Notes

1. Tolerance on angles  $\pm 7^\circ$ .
2. The centre line passing through base pins 3 and 14 and the Y-deflection axis are in line within  $10^\circ$ .
3. Cavity cap 4 is on the same plane as cavity caps 2, 3 and 5.

### Cavity Cap Connections

Cap	Element	Cap	Element
1	Grid 3 (flood gun)	4	Grid 4 (flood gun)
2	Grid 4 (flood gun)	5	Backing electrode
3	Grid 4 (flood gun)	6	Grid 3 (flood gun)

## Base Connections

2323A

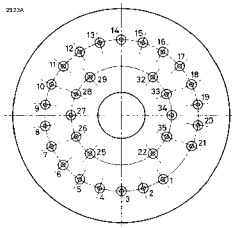

Pin	Element	Pin	Element
1	No connection	19	No connection
2	No connection	20	Internal connection.
3	Deflection plate X1		Do not use
4	Deflection plate X2	21	No connection
5	No connection	22	Heater (flood gun)
6	Grid 3 (writing gun)	23	Omitted
7	Internal connection. Do not use	24	Omitted
8	Heater (writing gun)	25	No connection
9	Heater (writing gun)	26	Internal connection.
10	Grid 1 (writing gun)		Do not use
11	No connection	27	Cathode (writing gun)
12	No connection	28	Internal connection.
13	Deflection plate Y1		Do not use
14	Deflection plate Y2	29	No connection
15	Grid 2 (writing gun)	30	Omitted
16	No connection	31	Omitted
17	Grid 2 (flood gun) and grid 4 (writing gun)	32	Grid 1 (flood gun)
18	No connection	33	Cathode (flood gun)
		34	No connection
		35	Heater (flood gun)